

WARRANTY

This Tent is covered by a 12 month warranty. The Company undertakes to replace or repair, free of charge, any defect which the Company considers to be due to faulty workmanship or material within 12 months of the purchase date, except for:

- Defects arising from neglect, misuse or unauthorised modifications.
- Damage caused by storm, abuse, misuse, dropping or other similar damage caused by or as a result of failure to follow storage or erection instructions.
- Unauthorised alterations, additions or repairs.
- Transportation or shipment costs to and from the Manufacturer or their recognised agents, for repair or assessment against a warranty claim.
- Damage caused due to UV degradation.
- Materials and/or labour costs to renew, repair or replace components due to fair wear and tear or condensation.
- Tents used on permanent sites or displays.

THIS DOES NOT AFFECT YOUR STATUTORY RIGHTS.

The Manufacturer and/or their recognised agents, directors, employees or insurers will not be held liable for consequential or other damages, losses or expenses in connection with or by reason of or the inability to use the tent for any purpose.

NOTE; Any claim(s) arising due to missing parts or faulty goods MUST be made before use. The manufacturer will not be responsible for any claims regarding missing parts or faulty items where the product has not been checked by the user prior to use.



SunnCamp

PATHFINDER 300/400

Thank you for purchasing the Pathfinder Tent 300/400 from SunnCamp.

Before erecting this tent, carefully read and understand these instructions. If there is anything you do not understand, contact your retailer for advice.

By following the instructions on erecting, dismantling, packing and storing the tent you will enjoy many years of trouble free camping.

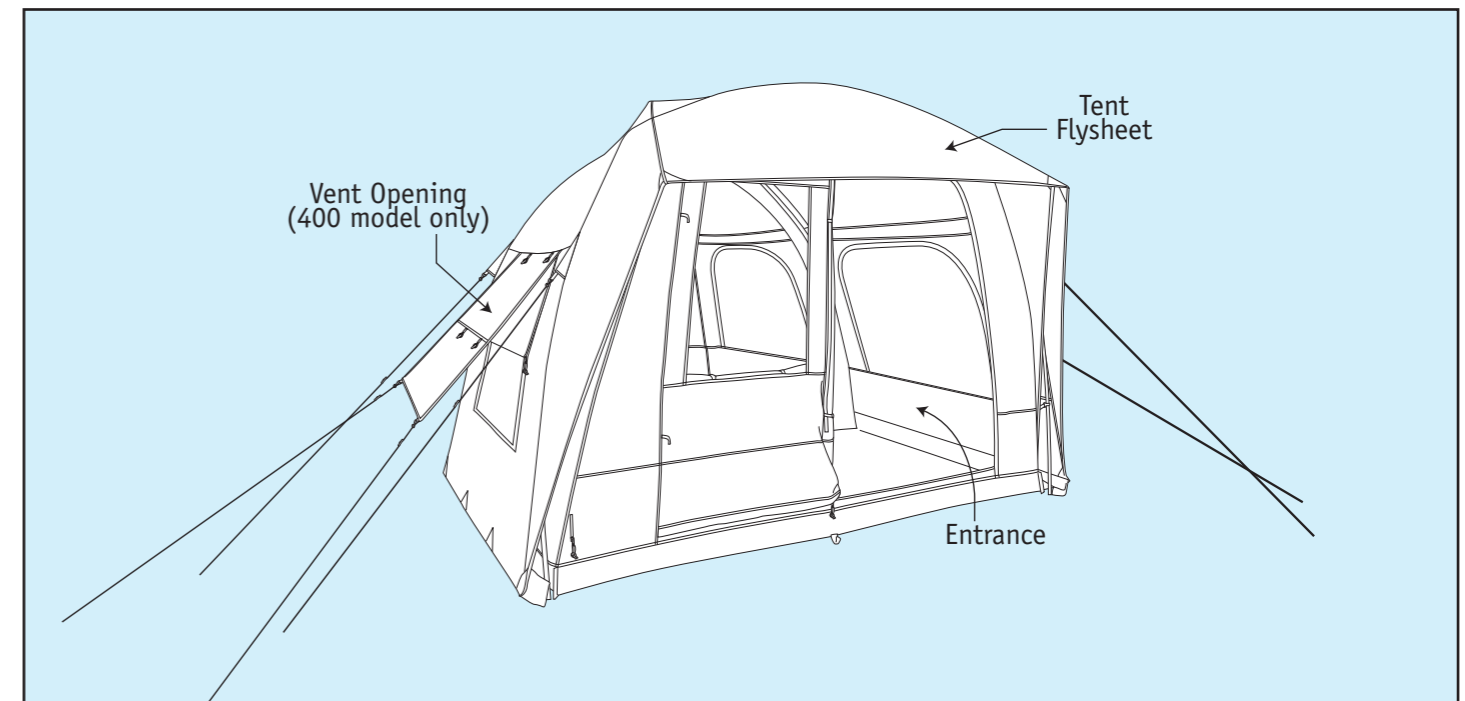

PARTS LISTING

Your Pathfinder 300/400 tent consists of the following items and you should check everything is present before setting off.

Tent Flysheet	1
Inner Tent with integrated ground sheet	1
Red Pole Single Elbow Shock Corded	2
Blue Pole Twin Elbow Shock Corded	1
Grey Pole Shock Corded	1
Tent Peg Bag	1
Repair Kit	1
Tent Carry-Bag	1

It is a requirement of the warranty that you unpack and erect this tent at home prior to proper use. This will enable you to familiarise yourself with the tent and check all parts are present and in good condition.

If you find any part missing or a fault with your tent, contact the retailer before returning or using it.

SITE SELECTION

Choose a location where the ground is flat, smooth and dry. Position the tent entrance away from the direction of the wind. Do not position on sharp, rocky or rough ground.

GETTING STARTED

Unpack the tent and place the carry-bag somewhere safe. Separate all components and check that everything is present.

You should now ensure that all entrances to the tent are closed with all zips fully secured. If this is not done now, the tent will be out of alignment when fitting the tent pegs.

POLES

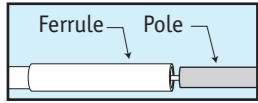

Take each Shock Corded Pole and slot together.

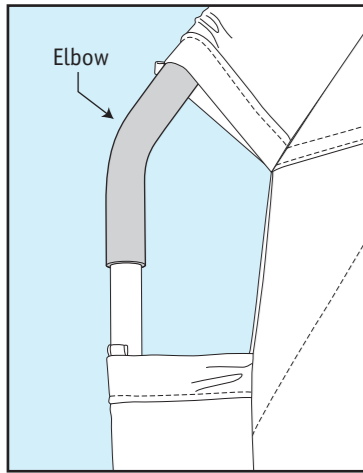

The Poles are folded down to aid storage. When fitting the pole sections together, make sure that the pole body is fully inserted into its adjoining ferrule.

The blue and red poles each have either one or two elbow sections which create the tents shape.

To ensure that all poles are inserted into the correct sleeve, both pole and sleeve carry the same colour coding.

INNER TENT

Lay the inner tent out on the selected ground area with the entrance correctly positioned. Starting with the four corners, secure the inner tent to the ground using the tent pegs.

Each pole end terminating at ground level is held captive by a pin on a ring fitted to the end of a webbing strap. The ring is also used as the securing point for the tent peg.

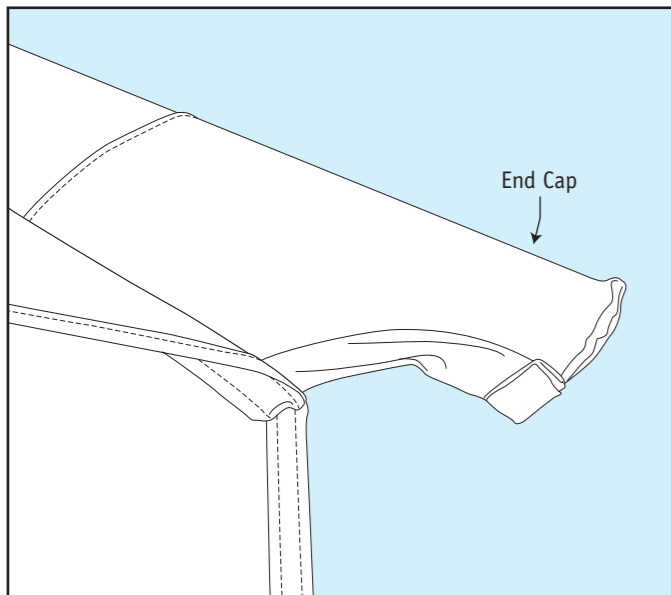

The two red poles cross over and terminate at the front of the tent where the ends are held captive within an end cap sewn into the sleeve.

Starting with one of the red crossover poles, insert the longer end of the pole into the sleeve which is marked with a red band. Feed it all the way until the end is inserted into the end cap. Repeat this with the remaining red pole.

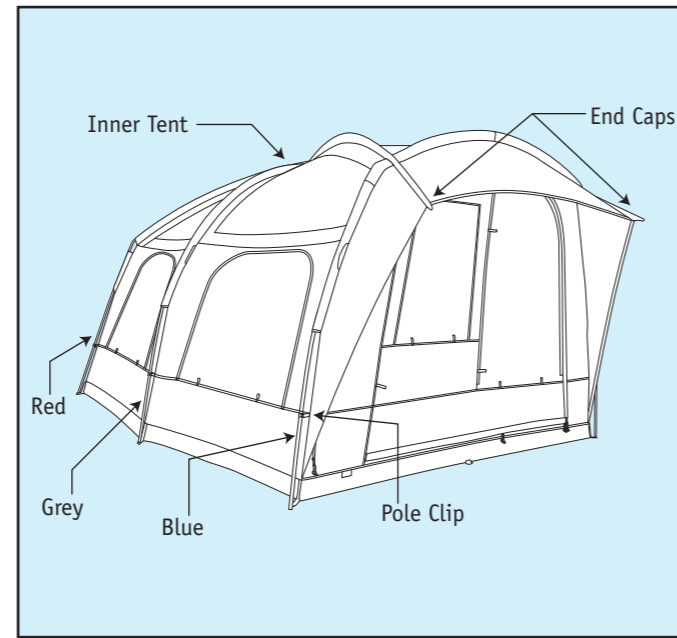

Now insert the grey and blue poles into their respective colour coded sleeves.

Insert the ring pin into the ends of both of the red crossover corners to bring the poles under tension.

Starting with the grey pole, insert the ring pin into the end of the pole. Next, go to the other end of the pole and insert the ring pin to bring the pole under tension. Repeat this with the remaining blue pole.

You can now clip the pole clips onto each pole to bring the inner tent into the correct shape.

TENT FLYSHEET

Lay the tent flysheet out on the selected ground area with the entrance correctly positioned.

With help, position the tent flysheet over the inner tent. At the point where the cross over poles meet, tie the tent flysheet's cord to secure in place with a bow.

You can now tie the remaining cords from the tent flysheet to the inner tents cross over poles with a bow.

Finally, secure the tent flysheet to the ground with the remaining tent pegs.

TENT PEGS

Starting with the four corners, secure the tent to the ground using the tent pegs. Secure the flysheet to the ground by inserting tent pegs through the pegging points.

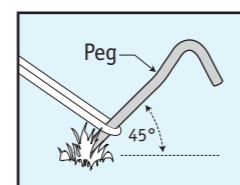

When inserting into the ground, the peg should be set at a 45 degree angle away from the tent. Pegs should be hammered into the ground using a suitable mallet and NOT pressed in with the foot. Most bent pegs are caused by using your foot rather than a mallet.

Peg removal can be made easier if you use a suitable extractor.

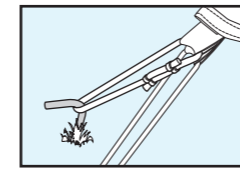

Pegs that are used to secure an entrance or door opening can be left slightly raised. This will allow easy hooking and unhooking when opening or closing the door.

GUY ROPES

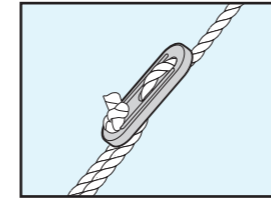

Secure each guy rope, positioning its tent peg at a suitable distance from the tent.

Once in position, tighten the ropes equally to bring the tent into its natural shape. DO NOT over tighten. To tighten, Hold the rope above the slider and pull the slider up. To release, again hold the rope above the slider and pull the slider down.

Remember that all guy ropes are a trip hazard especially in the dark.

ENTRANCES AND PORCHES

The front entrance is single skinned and can be rolled out of the way. When closed, the zip cover/baffle must be carefully secured into place, ensuring the Velcro tabs are aligned and the skirt correctly positioned, secured by tent pegs, to avoid water ingress should it rain.

VENT OPENING (400 model only)

The vent opening offers three options.

Fully closed, it is fastened down by the two securing zips. Note that the zip cover/baffle must be carefully pressed into place to avoid water ingress should it rain.

On vent with the securing zips opened and the cover held open using guy ropes (as per the main illustration).

Fully open, move the vent zip fully up to separate the sides from the main tent, than roll and secure with toggle and loop.

WINDOWS

The windows have curtains which can be closed and are secured in place either with hook and loop tape or full length zips. When open, carefully roll the curtain down and secure with toggle and loop.

SAFETY

It is advisable to have a 'Fire' bucket filled with water, placed outside the tent. Hopefully it will never be needed, but if it is, you will be glad you made the effort.

The tent's fabric is fire retardant, NOT fire proof and therefore you must not smoke or use a naked flame in or near the tent. This includes the traditional 'camp fire'.

Guy ropes can cause a trip hazard and should be marked so that passers by can see them.

Tent pegs are also a trip hazard and should not be left 'half in'.

CLEANING, STORING AND REPAIRS

Cleaning...

Both inside and outside of the tent should only be cleaned using fresh clean water and a damp cloth. Do not use detergents or chemical cleaners.

The inner ground sheet can be washed with a mild detergent.

Storing...

The tent is best stored in its original carry-bag, however, if the tent is dismantled when wet, you MUST not leave it stored until it has been thoroughly dried. After a wet pack-up, erect the tent as soon as possible and allow to fully dry naturally before repacking in the carry-bag.

If stored when wet, the tent will suffer from mildew and will become unusable.

Repairs...

Repairs to the tent should only be made by the manufacturer's recommended agents. Repairs made by an unauthorised party will make the manufacturers warranty void.

STORM AND WEATHER SUITABILITY

This tent is designed for light use in normal weather conditions. It is not suitable for storms, gales, sub zero or tropical conditions.

UV DETERIORATION

Prolonged exposure to direct sunlight can weaken the fabric of the tent. To avoid the risk of UV Deterioration, site the tent in a shaded area, where it will be protected from exposure to strong sunlight.

MOISTURE

Moisture collecting on the inside of the tent fabric is condensation caused by the occupier. It is NOT a sign of leakage.

Note that condensation, or damage caused by it, is NOT covered by the manufacturer's warranty.

SEAMS

This tent has all its main seams hot air taped to help prevent leakage. The remaining seams should be treated with a seam sealant to maximize the tents weatherproofing.

Seam sealant should also be applied to main seams where the tape has lost adhesion or has been damaged (tie points or suspension points for example).

Seam sealant is available from your Sunncamp stockist.

DISMANTLING

To dismantle the tent, simply reverse the erection procedure.

All poles must be dismantled and the tent should be carefully rolled prior to placing back in the carry-bag.

Make sure that any soil deposits are removed from the underside of the ground sheet and tent pegs.